

# Dell Force10 E300, E600i, and E1200i Systems Quick Start Guide

Regulatory Model: E300/E600i  
TeraScale/E600i ExaScale/  
E1200i TeraScale/E1200i  
ExaScale



Force10



# Dell Force10 E300, E600i, and E1200i Systems Quick Start Guide

Regulatory Model: E300/E600i  
TeraScale/E600i ExaScale/  
E1200i TeraScale/E1200i  
ExaScale



Force10

# Notes, Cautions, and Warnings



**NOTE:** A NOTE indicates important information that helps you make better use of your computer.



**CAUTION:** A CAUTION indicates potential damage to hardware or loss of data if instructions are not followed.



**WARNING:** A WARNING indicates a potential for property damage, personal injury, or death.

If you purchased a Dell n Series computer, any references in this publication to Microsoft Windows operating systems are not applicable.

---

**Information in this publication is subject to change without notice.**

© 2011 Dell Inc. All rights reserved.

Reproduction of these materials in any manner whatsoever without the written permission of Dell Inc. is strictly forbidden.

Trademarks used in this text: Dell™, the DELL logo, Dell Precision™, OptiPlex™, Latitude™, PowerEdge™, PowerVault™, PowerConnect™, OpenManage™, EqualLogic™, KACE™, FlexAddress™ and Vostro™ are trademarks of Dell Inc. Intel®, Pentium®, Xeon®, Core™ and Celeron® are registered trademarks of Intel Corporation in the U.S. and other countries. AMD® is a registered trademark and AMD Opteron™, AMD Phenom™, and AMD Sempron™ are trademarks of Advanced Micro Devices, Inc. Microsoft®, Windows®, Windows Server®, MS-DOS® and Windows Vista® are either trademarks or registered trademarks of Microsoft Corporation in the United States and/or other countries. Red Hat Enterprise Linux® and Enterprise Linux® are registered trademarks of Red Hat, Inc. in the United States and/or other countries. Novell® is a registered trademark and SUSE™ is a trademark of Novell Inc. in the United States and other countries. Oracle® is a registered trademark of Oracle Corporation and/or its affiliates. Citrix®, Xen®, XenServer® and XenMotion® are either registered trademarks or trademarks of Citrix Systems, Inc. in the United States and/or other countries. VMware®, Virtual SMP®, vMotion®, vCenter®, and vSphere® are registered trademarks or trademarks of VMWare, Inc. in the United States or other countries.

Other trademarks and trade names may be used in this publication to refer to either the entities claiming the marks and names or their products. Dell Inc. disclaims any proprietary interest in trademarks and trade names other than its own.

Regulatory Model: E300/E600i TeraScale/E600i ExaScale/E1200i TeraScale/E1200i ExaScale

2011 - 9 P/N 08VJV0 Rev. A00

# About this Guide

This document is intended as a Quick Start Guide to get new systems up and running and ready for configuration. For complete installation and configuration information, refer to the following documents:

<b>Documentation</b>	<b>E300</b>	<b>E600i</b>	<b>E1200i</b>
Hardware installation and power-up instructions	<i>Installing and Maintaining the E300 System</i>	<i>E600i System Installation Guide</i> <i>E600i TeraScale Installation Guide</i>	<i>E1200i ExaScale Installation Guide</i> <i>Installing and Maintaining the E1200i System</i>
Software configuration	<i>FTOS Configuration Guide</i>	<i>FTOS Configuration Guide</i> <i>FTOS Configuration Guide for ExaScale</i>	<i>FTOS Configuration Guide</i> <i>FTOS Configuration Guide for ExaScale</i>
Command line interface	<i>FTOS Command Line Reference Guide</i>	<i>FTOS Command Line Reference Guide</i> <i>FTOS Command Line Reference Guide for ExaScale</i>	<i>FTOS Command Line Reference Guide</i> <i>FTOS Command Line Reference Guide for ExaScale</i>
Latest updates		<i>FTOS Release Notes for the E-Series TeraScale</i> <i>FTOS Release Notes for the E-Series ExaScale</i>	<i>FTOS Release Notes for the E-Series TeraScale</i> <i>FTOS Release Notes for the E-Series ExaScale</i>



# Installing the Hardware

This guide assumes all site preparation has been performed before installing the chassis.

## Installing the Chassis

To install an E-Series chassis, Dell Force10 recommends that you complete the installation procedures in the order presented below.



**NOTE:** Unless stated otherwise, the installation instructions below apply to all of the E-Series chassis.

Always handle the system and its components with care. Avoid dropping the switch or its field replaceable units.



**CAUTION:** The E-Series systems are packaged in one or two separate containers. Use an equipment lift or pallet jack to lift or install the chassis. Lifting the system by its shelves will cause damage to the chassis.



**NOTE:** If you are installing the chassis without using an equipment lift or pallet jack, remove all AC power supplies, the fan tray, line cards, RPMs and SFMs from the chassis prior to lifting it.



**CAUTION:** Always wear an ESD-preventive wrist or heel ground strap when handling the chassis and its components. As with all electrical devices of this type, take all necessary safety precautions to prevent injury when installing this system. Electrostatic discharge (ESD) damage can occur if components are mishandled.

## Installing the Equipment Rack Shelf Bar

The equipment rack shelf bar must be installed first for all of the E-Series chassis.

Step	Task
1	Determine the chassis mounting location in the equipment rack.
2	Orient the bar with the arrows pointing upward. The smooth side of the bar should face outward.

Step	Task
3	Attach the bar to the equipment rack brackets using the mounting screws provided by the rack manufacturer.

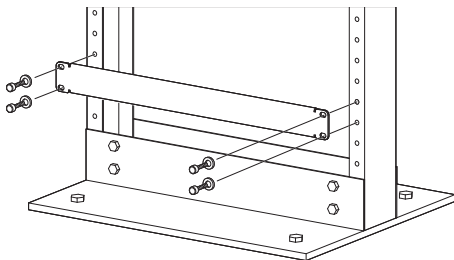

## Installing the Chassis in a Two-Post Rack

Step	Task
1	If you are center or rear mounting the chassis in a 19-inch rack, make sure that the mounting brackets are properly positioned. If you are mounting the chassis in a 23-inch rack, install the 23-inch adapters.
2	Using a hand cart, pallet jack, or forklift, align the rack-mount holes with the equipment rack holes, situating the chassis on top of the equipment rack shelf bar.
3	Insert rack mounting screws in the holes that are not obscured by the front shipping cover. Tighten the screws.
4	Loosen and remove the screws attaching the front shipping cover. Remove the cover.
5	Insert the remaining rack mounting screws and tighten to secure the chassis in the rack.



## Installing E300 Chassis into Rack

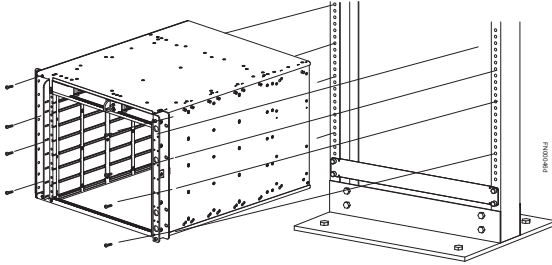

## Installing E600i and 1200i into Rack

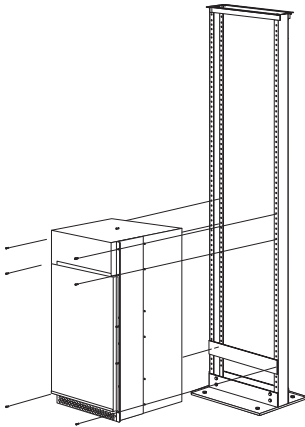

## Attach a Ground Cable to the Chassis



**NOTE:** The rack installation ears are not suitable for grounding.



**CAUTION:** Grounding conductors *must* be made of copper. Do not use aluminum conductors.



**NOTE:** Coat the lugs with an anti-oxidant compound prior to crimping. Bring any un-plated mating surfaces to a shiny finish, and coat with an anti-oxidant prior to mating. Plated mating surfaces must be clean and free from contamination.



**WARNING:** You must complete the ground connection before proceeding with the DC PEM installation. It is also recommended that you complete the grounding before connecting the AC PSU power.

## E300 DC PEM Chassis Ground

Step	Task
1	Locate the chassis ground connector studs on the PEM front panel. The two studs on the upper left are the ground connection.

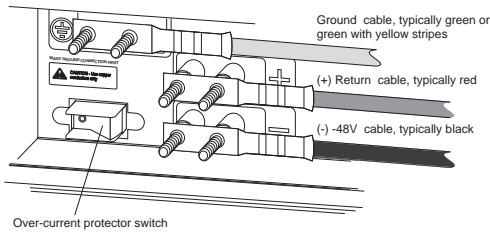

- 2 Remove all nuts and washers from the two ground studs.
- 3 Apply a coat of anti-oxidant paste to the connector studs.
- 4 Install the grounding cable. This cable is typically green or green and yellow.

 **NOTE:** Termination points require UL-listed 2-hole lug with 1/4-inch holes on 3/4-inch spacing.

- 5 Replace the two washers and nuts on the studs.
- 6 Secure the nuts with a nut driver or torque wrench (not to exceed 4 ft/lbs).
- 7 Connect the opposite end of the grounding cable to the appropriate nearest grounding.

## E600i TeraScale and ExaScale DC Chassis Ground

Step	Task
1	Remove one outer nut and one washer from each of the six studs. The inner nut should remain tight on the stud, at no more than 25 inch-lbs.
2	Locate the chassis ground connector studs on the PEM front panel. The two bottom studs are the ground connection.

Step	Task
3	<p>Attach the grounding cable onto the ground studs. The grounding cable must comply with your local electrical codes in size and color (typically the color is green or green with yellow stripe),</p> <p> <b>NOTE:</b> Grounding cables must be terminated only with a UL-listed 2-hole lug with 1/4-inch holes on 3/4-inch spacing.</p> <p>Cable Connector Required for E600i DC</p>

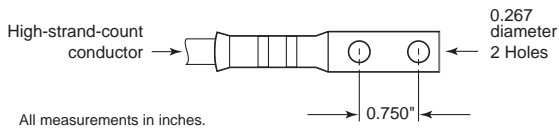

- 4 Replace the two washers and nuts.
- 5 With a 7/16-inch box or socket wrench, tighten the nuts to 25 in-lbs.
- 6 Connect the opposite end of the grounding cable to the nearest appropriate facility grounding post.

## E1200i TeraScale and ExaScale AC Chassis Ground

Step	Task
1	Locate the chassis ground connector nuts on the rear of the chassis.
2	Install the grounding cables to the ground nuts. The grounding cable must comply with your local electrical codes in size and color (typically the color is green or green with yellow stripe).  <b>NOTE:</b> Grounding cables must be terminated only with a UL-listed 2-hole lug with 1/4-inch holes on 3/4-inch spacing. <b>Cable Connector Required for E1200i AC</b>

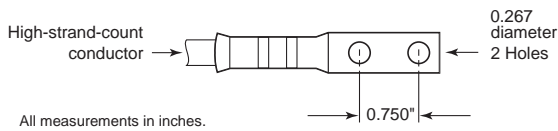

3	Use ANSI UNC 1/4-20 x 12 bolt.
4	Tighten the bolt (torque should not exceed 25 inch/lbs).
5	Connect the opposite end of the grounding cable to the nearest appropriate facility grounding post.

## E1200i TeraScale and ExaScale DC Chassis Ground

Step	Task
1	Remove one outer nut and one washer from each of the six studs. One nut should remain, tight on the stud. If the inner nut is loose, re-tighten it to 25 inch/lbs, maximum.
2	Locate the chassis ground connector studs on the PEM front panel. The two rightmost studs are the ground connection.

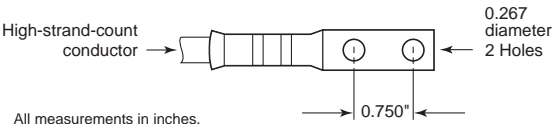
Step	Task
3	<p>Install the grounding cables to the ground studs. The grounding cable must comply with your local electrical codes in size and color (typically the color is green or green with yellow stripe).</p> <p> <b>NOTE:</b> Grounding cables must be terminated only with a UL-listed 2-hole lug with 1/4-inch holes on 3/4-inch spacing.</p> <p>Cable Connector Required for E1200iDC PEM</p> 
4	Replace the two washers and nuts on the studs.
5	With a 7/16-inch box or socket wrench, tighten the nuts (torque should not exceed 25 inch/lbs).
6	Connect the opposite end of the grounding cable to the nearest appropriate facility grounding post.

## Installing Power Modules

This section provides instructions to install AC Power Supply Units (PSUs) and DC Power Entry Modules (PEMs) in each E-Series system. E-Series systems may contain only one type of power module—AC or DC.

Unless otherwise stated, each AC and DC power supply for each E-Series system is shipped with a Dell Force10-approved power cord and only that cord should be used to connect the power supply to the appropriate outlet.

 **WARNING:** To prevent electrical shock, make sure the system is grounded properly. If you do not ground your equipment correctly, excessive emissions may result. Use a qualified electrician to ensure that the power cables meet your local electrical requirements.

### E300 AC Power Modules

The E300 system requires a minimum of two AC Power Supplies.

 **WARNING:** Electrostatic discharge (ESD) damage can occur when components are mishandled. Always wear an ESD-preventive wrist or foot-heel ground strap when handling chassis components.



 **CAUTION:** Before removing and replacing a power supply module, determine if the E300 is in full facility redundancy or non-redundant power. Operating in non-redundant power will require a complete system power off when removing and replacing a power supply.

 **CAUTION:** The power cord is the main power disconnect device; ensure that the socket-outlet is located/installed near the equipment and is easily accessible.

The E300 contains four power supply slots in the rear of the chassis.

Each AC power supply contains two LEDs: Status and AC.

To install an AC power supply:

Step	Task
1	Toggle the Standby Switch of the power supply to the standby position.  <b>NOTE:</b> If the E300 is already operating in redundant mode, you can insert a new power supply without shutting down the E300.
2	Slide the power supply into any open power supply slot.  <b>CAUTION:</b> Fill all four power supply slots with power supplies or filler blanks before tightening the power supply screws. Doing this ensures that each power supply is aligned correctly. Attempting to tighten screws without all power supply slots filled will cause misalignment with screw holes, which might damage the chassis permanently.

Step	Task
3	<p>For bottom units, ensure that the EMI gasket along the edge of each power supply is compressed smoothly before securing each power supply into place using the captive screws.</p> <p>For top units, it may be necessary to lift the unit slightly to install the captive screws.</p> <p>As a best practise, insert the two captive screws of each power supply by hand before tightening them all.</p> <p> <b>CAUTION: Tighten the screws with a #2 Phillips screwdriver. Use no more than eight pounds of torque (light torque with a manual screwdriver). Too much torque can damage fasteners and that improper use of power drivers can cause even greater damage.</b></p>
4	Plug the AC power cord into the AC power inlet in the face of the power supply.
5	Plug the AC power cord into an AC power outlet.
6	Toggle the standby switch of the power supply to the On position.



**NOTE:** Power modules are not field serviceable.

## E300 DC Power Modules

The E300 supports a minimum of one DC PEM. You must have only one type of power module in the chassis; you cannot install a mixture of power modules.

You must provide your own cables to connect to a remote power source (a circuit breaker panel, for example) in your equipment rack or facility. Cables must be sized to meet the following criteria:

- Rated for 60A service to allow for a fully loaded E300 system per NEC in the United States or internationally, per local safety codes.
- Limit voltage drop across the cable length to 0.5V or less.

Before you make the cable connections, apply a coat of anti-oxidant paste to unplated metal contact surfaces. File unplated connectors, braided straps, and bus bars to a shiny finish. It is not necessary to file and coat tinned, solder-plated, or silver-plated connectors or other plated connection surfaces, such as those on the PEM studs.



**NOTE:** Please take precautions against over-tightening the screws or nuts on this device.

## Installing a DC PEM

Step	Task
1	Turn the remote power source (the circuit breaker panel) to the OFF position.
2	Turn the over current protector (located on the PEM front panel) to the OFF position.
3	Loosen the PEM safety cover retaining screw and remove the cover.
4	Slide the PEM into power slot 0 or 1.   <b>CAUTION: Fill all power supply slots with power supplies or filler blanks before tightening the power supply screws. Doing this ensures that each power supply is aligned correctly. Attempting to tighten screws without all power supply slots filled will cause misalignment with screw holes, which might damage the chassis permanently. If you are only installing one PEM, replace the empty slot with two blank panels. (CC-E300-BLNK-PWR.)</b>
5	Tighten the two locking screws on each module with a #2 Phillips screwdriver to secure the PEM in place. As a best practise, insert all screws before tightening each one.
6	Remove the outer nut and washer from each of the remaining studs.
7	Connect the -48 VDC and Return cables from each PEM to the remote power sources. <ol style="list-style-type: none"><li>Verify that the remote power source is in the OFF position.</li><li>Locate the appropriate studs on the PEM front panel. The two top studs are the return (+) connection. The cable attached to these studs is typically red. The two bottom studs on the PEM are the -48 VDC (-) connection. The cable attached to these studs is typically black. Power cables must be terminated only with a UL-listed 2-hole lug to accommodate 1/4-inch studs with 3/4-inch spacing.</li><li>Apply a coat of anti-oxidant paste to the connector studs.</li><li>Replace the washers and nuts on the studs.</li><li>Route the terminated cables out toward the rack rail.</li><li>Secure the nuts with a nut driver or torque wrench (not to exceed 4 ft/lbs).</li></ol>



Step	Task
8	Replace the safety cover and tighten the captive screw with a #2 Phillips screwdriver.
9	Turn the Over Current Protector to the ON position.
10	Turn the remote power source (the circuit breaker panel) to the ON position.

## E600i AC Power Modules

The E600i requires a minimum of two AC Power Supplies.

Power Supply Input	Minimum (N)	Redundancy
220 VAC	3	N+1
100 VAC	2	N+1

The chassis has four power supply slots. You may install AC power supplies in any slot.

 **WARNING: Class 1 laser product.**

The 2500W AC Power Supply Unit is capable of operating at either 100 VAC or 220 VAC.

 **CAUTION: Before removing and replacing a power supply unit, determine if the E600i is in full redundancy or non-redundant mode. Operating in non-redundant mode will require a complete system power off when removing and replacing a power supply.**

 **NOTE:** Do not mix power supply versions. Installing a 2500W-AC2 power supply into a chassis with 2500W-AC power supplies already installed may result in unpredictable behavior. FTOS will declare an alarm when the PSUs are mixed.

To install an AC power supply:

Step	Task
1	Verify that the power switch on the power supply is in the OFF position.
2	Orient the power supply handle to the left, and slide the backplane connector end into a power supply slot.

<b>Step</b>	<b>Task</b>
3	Secure the power supply into place by tightening the two locking screws to 5 in-lbs.
4	Plug an AC power cord into the socket on the front of the unit: <ul style="list-style-type: none"> <li>a Loosen the power cord retainer thumb screw.</li> <li>b Rotate the retainer clockwise away from the socket and plug the power cord into the socket.</li> <li>c Rotate the retainer counter clockwise over the power cord, and tighten the thumb screw to secure the power cord.</li> </ul>
5	Plug the AC power cord into an AC outlet.
6	Toggle the power supply switch to the ON position, and verify that Status LED lights green.

## E600i DC Power Modules

The system requires a minimum of one load-sharing PEM to operate, but two are recommended for redundancy. Connect the E600 PEMs to the appropriate branch circuit protection as defined by local electrical codes.

You must provide your own cables to connect to a remote power source in your equipment rack. Verify that your cables are:

- Rated for at least 80A service to allow for a fully loaded E600i system at low input voltage per your local electrical codes.
- Limit voltage drop across the cable length to 0.5V or less.

Before you make the cable connections, apply a coat of anti-oxidant paste to unplated metal contact surfaces.

File unplated connectors, braided straps, and bus bars to a shiny finish. It is not necessary to file and coat tinned connectors or other plated connection surfaces, such as on the PEM studs.

### Installing a DC PEM

<b>Step</b>	<b>Task</b>
1	Make sure that the remote power source (the circuit breaker panel) is in the OFF position.
2	Make sure that the over current protector (located on the PEM front panel) is in the OFF position.

Step	Task
3	Loosen the retaining screw and remove PEM safety cover.
4	Slide the backplane connector end of the PEM into Power Supply Slot 1 or 3. Secure the PEM to the chassis by tighten the two locking screws.

## E1200i AC Power Modules

When installing the AC power supplies in the E1200i system, make note of the following:

- E1200i ExaScale AC system: The E1200i AC system requires a minimum of 3 AC power supplies in a shelf (0, 1, 2 or 3, 4, 5) to operate. For full redundancy use 6 power supplies so that if one power supply fails in one shelf, the system remains operational operates with the 3 power supplies in the other shelf. To comply with safety agency and EMI regulations, you must install the AC-cord retainer over all power cords. The E1200i AC chassis contains 6 AC power supply slots.
- E1200iTeraScale AC system: The E1200i AC system requires a minimum of two AC power supplies to operate, three for power redundancy, four for facility redundancy (2+2), and 6 for 3+3 redundancy. To comply with safety agency and EMI regulations, you must install the AC-cord retainer over all power cords. The E1200i AC chassis contains six AC power supply slots.



**NOTE:** If you are installing only two power supplies, they must be installed in the same row. FTOS will generate an error message if the two power supplies are not in the same row.



**NOTE:** The On/Standby switch disconnects power to the rest of the chassis from all 6 AC power supplies. When the AC cord is attached, power supply fans will spin and the LEDs will indicate status while the On/Standby switch is in Standby.



**CAUTION: An E1200i AC power supply still has power after extraction, and has completely powered off when the fans have stopped rotating. When replacing a power supply, to avoid arcing and discoloration of the supply and the chassis pins, please wait for the fans to stop rotating before reinserting the supply.**

Step	Task
1	Make sure that the On/Standby switch, located on the left side of plug AC-0, is in the Standby (up) position.

Step	Task
2	Loosen the cord retainers locking screws (if needed) and tilt the AC-cord retainer up approximately 15 degrees and gently slide the cover away from the chassis.
3	Slide the power supplies into their slots until the module front is flush with the shelf front.
4	Connect the Power Supply cord to the designated socket.
5	Re-install the AC-cord Retainer by tilting approximately 15 degrees and gently sliding in the long edge just above the AC cords.
6	Secure the retainer by tighten the locking screws on either side of the retainer.

**⚠ WARNING: Leakage Current (High Touch Current) in AC-powered systems: AC power cords are secured to the power inlet using the provided brackets. The power cord plugs must be secured to the building outlets by the qualified chassis installer or a qualified electrician.**

## E1200i DC Power Modules

The E1200i DC system requires a minimum of one DC Power Entry Module (PEM) to operate, but two are recommended for redundancy. To comply with safety agency and EMI regulations, you must install covers on all power supply slots not containing a PEM. Connect the PEMs to the appropriate branch circuit protection as defined by local electrical codes.

The E1200i DC chassis contains two DC PEM slots.

You must provide your own cables to connect to a remote power source (for example, a circuit breaker panel) in your equipment rack or office. Cables must be sized to meet the following criteria:

- Rated for at least 150A service to allow for a fully loaded E1200i DC system at low input voltage per your local electrical codes.
- Limits voltage drop across the cable length to 0.5V or less.

Before you make the cable connections, apply a coat of antioxidant paste to unplated metal contact surfaces. File un-plated connectors, braided straps, and bus bars to a shiny finish. It is not necessary to file and coat tinned connectors or other plated connection surfaces, such as on the E1200i DC PEM studs.



**WARNING: An external disconnect shall be provided and shall be easily accessible. Dell Force10 recommends that you use a 150A circuit breaker.**

Use the following steps to install a DC PEM:

Step	Task
1	Make sure that the remote power source (the circuit breaker panel) is in the OFF position.
2	Make sure that the over-current protector (located on the PEM front panel) is in the OFF position.
3	Loosen the retaining screw and remove the PEM safety cover.
4	Slide the PEM into the 0 or 1 slot: <ul style="list-style-type: none"><li>a Lift up and hold the PEM interlock lever and carefully push the unit inward to fully seat it to the backplane. When the PEM is fully inserted, the interlock lever will drop to hold the PEM in position.</li><li>b Tighten the two locking screws with a #2 Phillips screw driver to secure the PEM. Do not exceed 5 inch/lbs torque.</li></ul>
5	Connect the -48 VDC and Return cables from each PEM to the remote power sources (circuit breakers A and B). <ul style="list-style-type: none"><li>a Check that the remote power sources (for example, circuit breakers) are in the OFF position.</li><li>b Locate the appropriate studs on the PEM front panel.</li><li>c The two left most studs on the PEM are the -48 VDC (-) connection. The cable attached to these studs is typically black. The two middle studs are the return (+) connection. The cable attached to these studs is typically red.</li><li>d Install the -48 VDC and Return cables on the studs. The cables should be of the size and color to comply with local electrical codes.</li></ul> <p> <b>NOTE:</b> Power cables must be terminated only with a UL-listed 2-hole lug with 1/4-inch studs with 3/4-inch spacing.</p> <ul style="list-style-type: none"><li>e Replace the washers and nuts on the studs.</li><li>f With a 7/16-inch box or socket wrench, tighten the nuts.</li></ul>
6	Route the terminated cables down and toward the rack rail.
7	Replace the safety cover and tighten the captive screw with a #2 Phillips screwdriver.

Step	Task
8	Check that the over-current protector (located on the PEM front panel) is in the OFF position. Energize the remote power source. The Voltage LED should be green. If it is amber, the -48 VDC and Return cables are connected incorrectly or are reversed.

## Installing RPMs, Line Cards, and SFMs

### Unpacking Cards

 **WARNING: Electrostatic discharge (ESD) damage can occur when components are mishandled. Always wear an ESD-preventive wrist or foot-heel ground strap when handling RPMs, SFMs, or line cards. Connect your ESD strap to the grounding plug located on the front of the chassis. See Figure 2 for ESD strap connector location. After you remove the original packaging, place RPMs, SFMs, and line cards on an antistatic surface.**

 **CAUTION: Do not supply power to your system until the power supplies and fan tray(s) are installed and verified, and RPMs, SFMs, line cards, and any blank panels are installed.**

### Blank Panels

 **CAUTION: To avoid a chassis over-temperature condition, install blanks for RPMs, SFMs, and line card slots not in use. Always replace cards or blanks immediately.**

Blank panels for RPMs, SFMs, and line cards must be installed in empty slots to control airflow. Blank panels are shipped with the system to ensure that all chassis slots are installed with operational modules or blanks.

## E300

### RPMs

The E300 system requires the installation of at least one RPM, although two are recommended for redundancy. RPMs are designed to be installed in either the R0 or R1 slot. Do not force RPMs into line card slots. RPMs are keyed differently than line cards to prevent improper installation.

## Installing the RPMs and Line Cards



**CAUTION:** Use of controls or adjustments or performance of procedures other than those specified herein may result in hazardous laser exposure.



**NOTE:** Line cards are hot swappable.

Step	Task
1	Hold the card by the edges. Avoid touching the printed circuit board and connector pins. Extend the left and right card levers before you insert the card into the slot.
2	Align the card with the guide and gently slide it into the slot until you feel the connectors engage with the chassis backplane.
3	Rotate the levers to seat the backplane connectors and line card in place.
4	Secure card and blanks in place by tightening the left and right captive screws on each card.
5	Follow the same installation procedure for the remaining cards and slots.

## Installing Switch Fabric Modules (SFMs)

Two SFMs are required for the E300 system to operate optimally.

Step	Task
1	Remove an SFM from the anti-static packaging. Hold the card by the edges. Avoid touching the printed circuit board and connector pins. Extend the card lever before you insert the card into the slot.
2	Align the SFM with the guide and gently slide it into the slot until you feel the connectors engage with the chassis backplane.
3	Rotate the lever to seat the backplane connectors and card in place.
4	Secure each SFM in place by tightening the captive screw.
5	Continue the process for the remaining SFMs.
6	Install blank panels in all unused slots.



**NOTE:** If you are not operating the system with SFM redundancy, install a blank panel in the unused slot.

## E600i

### RPMs

The E300 system requires the installation of at least one RPM, although two are recommended for redundancy. RPMs are designed to be installed in either the R0 or R1 slot. Do not force RPMs into line card slots. RPMs are keyed differently than line cards to prevent improper installation.

### Line Cards

Your E600i configuration requires a minimum of one line card. Line cards are hot swappable.

### Installing the RPMs and Line Cards



**CAUTION:** Use of controls or adjustments or performance of procedures other than those specified herein may result in hazardous laser exposure.



**NOTE:** Line cards are hot swappable.

Step	Task
1	Hold the card by the edges. Avoid touching the printed circuit board and connector pins. Extend the left and right card levers before you insert the card into the slot.
2	Align the card with the guide and gently slide it into the slot until you feel the connectors engage with the chassis backplane.
3	Rotate the levers to seat the backplane connectors and line card in place.
4	Secure card and blanks in place by tightening the left and right captive screws on each card.
5	Follow the same installation procedure for the remaining cards and slots.

### Installing Switch Fabric Modules (SFMs)

A minimum of four SFMs are required in order for the E600i system to operate properly. There is an additional slot available for a redundant SFM.



**NOTE:** If you are not operating the system with SFM redundancy, install a blank panel in the unused slot.



Step	Task
1	Remove an SFM from the anti-static packaging. Hold the card by the edges. Avoid touching the printed circuit board and connector pins. Extend the card lever before you insert the card into the slot.
2	Align the SFM with the guide and gently slide it into the slot until you feel the connectors engage with the chassis backplane.
3	Rotate the lever to seat the backplane connectors and card in place.
4	Secure each SFM in place by tightening the captive screw.
5	Continue the process for the remaining SFMs.

## E1200i

### RPMs

The E1200i system requires the installation of at least one RPM, although two are recommended for redundancy.

- Do NOT remove the cards from their protective bags until you are ready to install them in a chassis.
- When you are ready to install the cards, unwrap and install one card at a time, starting with the right-most slot (Slot 13 for line cards, Slot R1 for RPMs, and Slot 9 for SFMs) ending with the left-most slot (Slot 0 for line cards, Slot R0 for RPMs, and Slot 0 for SFMs).

RPMs are designed to be installed in either the center R0 or R1 slots. Since FTOS searches for an RPM in slot 0 first, Force 10 recommends you install your RPM in slot 0 when only running with one RPM. Do not force RPMs into line card slots. RPMs are keyed differently than line cards to prevent improper installation.

### Line Cards

Your E1200i configuration requires a minimum of one line card. Line cards are hot-swappable. There are 14 line card slots available in the E1200i chassis. A minimum of one line card is required for operation. Line cards are installed in slots 0 through 13. Ports on line cards are numbered from the top, starting from 0.

## Preparing and Installing RPMs and Line Cards

To prolong the life of the EMI seals, begin installing cards in the right-most slot (slot 13), filling the slots leftward (slot 12, then slot 11, then slot 10, and so on).

Step	Task
1	Remove the line card from its box and carefully remove the line card from the anti-static packaging.
2	Align the RPM with the guide and gently slide it into the slot until you feel the connectors engage with the chassis backplane.  <b>NOTE:</b> Hold the card by the edges. Avoid touching the printed circuit board and connector pins. Extend the top and bottom card levers before you insert the card into the slot.
3	Rotate the levers to seat the backplane connectors and line card in place.
4	Secure card and blanks in place by tightening the top and captive screws on each card.
5	Follow the same installation procedure for the remaining cards and slots, in the appropriate order.

## Installing Switch Fabric Modules (SFMs)

A minimum of eight SFMs are required in order for the E1200i system to operate properly. Slot 9 allows for a redundant SFM, allowing up to ten SFMs in the E1200i system.

 **CAUTION: If you are not operating your system with a redundant (tenth) SFM, you must install an SFM blank to avoid overheating and ensure EMI containment.**

Install SFMs from the right-most slot (9) to the left-most slot (0).

Step	Task
1	Remove an SFM from the anti-static packaging.
2	Align the SFM with the guide and gently slide it into the slot until you feel the connectors engage with the chassis backplane.  <b>NOTE:</b> Hold the SFM by the edges. Avoid touching the printed circuit board and connector pins. Extend the top and bottom card levers before you insert the card into the slot.

---

Step	Task
3	Rotate the lever to seat the backplane connectors and card in place.
4	Secure each SFM in place by tightening the captive screw.
5	Continue the process for the remaining SFMs.
6	Align any blank panels with the guides and gently slide toward the backplane. Secure each blank panel by tightening the single captive screw.

---

## Power Up Sequence

 **WARNING: Make sure that the switch on the remote power source is in the OFF position until you are ready to supply power to the chassis.**

Follow the instructions in this section to power up all E-Series TeraScale and E-Series ExaScale systems.

### Preparation

Before you supply power to your chassis, re-inspect your equipment rack and chassis, verify that:

- The equipment rack is properly secured and grounded.
- The chassis is bolted and secured into your equipment rack.
- Each power supply module (AC or DC) is properly installed and grounded.
- Each power supply module's switch is in the OFF position.
- The safety covers are installed on each DC PEM.
- Power cables connect to a compliant remote power source.
- The fan tray is installed and cannot be removed by pulling on the fan tray handles.
- All line cards, RPMs, and SFMs are properly installed and secured.
- All chassis slots are filled. Blank panels and covers are installed in all empty slots.

## Supplying Power

---

Step	Task
1	Energize the remote power source.
2	Flip the switch on the AC power supplies or DC PEM to the ON position.
3	In a DC PEM, the Status LED should be green.  In an AC Power Supply, the top Input AC and Output LEDs should be green. If these LEDs are not lit or the Status LED is amber on a DC PEM, check that the unit is properly installed. Verify the power source. If the LEDs remain unlit, power off all modules and replace the unit.
4	The fan tray LED should be green (online). Verify that air is flowing through the chassis.  If the fans are not operating properly or air is not flowing through the chassis, power off the chassis at the power module. Ensure that the fan is properly installed. Verify the power source. If the fan impeller LED remains unlit, replace the fan impeller.

---

To turn the power off on the power modules, use one of the following methods:

- On the DC PEMs, flip the switch to the OFF position. Make sure the AC power supplies Status LEDs are not lit.
- On the AC Power Supplies, flip the switch to the OFF position and unplug the power cord from the socket on the front of the Power Supply. Make sure the Input AC and Output DC LEDs are not lit (they may flash as they power down.)

### Booting to the CLI Prompt

After you supply power to the system, the following should occur:

- The fans should be operating.
- The green (online) fan tray, power module, RPM, SFM, and line card LEDs should be lit and remain lit as long as the system is receiving power and is operational.

When you supply power to the system, the system performs a series of power-on self tests. RPM, line card, and SFM LEDs blink as the diagnostic programs run. No user interaction is required at this point. Observe the process on your console

monitor. When the boot process is complete, the card LEDs remain online (green) and the console monitor displays the Command Line Interface (CLI) prompt.



**NOTE:** Do not press any keys or control sequences at any time during the boot process. Doing so may cause the boot process to terminate.



**CAUTION: Leakage Current (High Touch Current):** The AC power cords are secured to the power inlet using the provided bracket. The power cord plugs must be secured to the building outlets by the chassis installer or a qualified electrician.

## Fans

For complete information on installing system FAN trays, refer to your system's installation guide.

### E300

Your E300 chassis contains one field-replaceable fan tray. Air flows through the system toward the fans and is exhausted on the fan side of the chassis. Air circulates from the right side to the left. Minimum air flow is 665 cubic feet per minute (CFM).

### E600i TeraScale and E600i ExaScale

Your E600i chassis contains one field-replaceable fan tray. Air flows through the system from a filtered intake vent located in the lower part of the chassis. Air circulates from the bottom front side to the back side and exhausts primarily through a top rear vent. The variable speed fan rate is reduced at normal operating temperatures and fans reach full speed at 40° C (104° F).

### E1200i TeraScale and E1200i ExaScale

Your E1200i chassis contains two field-replaceable fan trays. Air flows through the system from a filtered-intake vent located in the lower part of the chassis. Air circulates from the bottom front (and sides) to the back and exhausts through a top rear vent. The variable fan speed is reduced at normal operating temperatures and increases to full speed as operating temperatures increase, up to 104° F (40° C).

# E300 Specifications

## E300 Chassis Physical Design

Parameter	E1200i AC Specifications
Height	14 inches (35.6 cm)
Width	17.4 inches (44.2 cm)
Depth (without cable management system)	24 inches (61 cm)
Chassis weight with factory-installed components (backplane and air filter)	90 pounds (approx.) (41 kg)
Weight fully loaded (backplane, air filter, 1 fan tray, 2 SFMs, 2 RPMs, and 6 line cards)	170 pounds (approx.) (77 kg)
<b>Thermal Output</b>	
Maximum for fully loaded chassis	2500 W (8500 BTU/hour)
Normal operating conditions (25 deg.C, -48V-line)	2000 W (6800 BTU/hour)
Minimum for chassis with one 24-port 1GE line card	800 W (2700 BTU/hour)

## E300 Environmental Parameters

Parameter	Specifications
<b>Operating</b>	
Temperature	40° to 105°F (5° to 40°C)
Maximum altitude	No performance degradation to 10,000 feet (3,048 meters)
Relative humidity	5 to 85 percent, non-condensing
<b>Non-operating</b>	
Temperature	-40° to 158°F (-40° to 70°C)
Maximum Altitude	15,000 feet (4,572 meters)
Relative Humidity	5 to 95 percent, non-condensing

## E300 AC Power Supplies Power Requirements

<b>Parameter</b>	<b>Specifications</b>
Nominal input voltage	100 - 240 VAC 50/60 HZ
Maximum AC Power Supply Input Current (based on 800W output for 100/120V line and 1200W output for 200/240V line.)	10 A @ 100 VAC per AC Power Supply 8.3 A @ 120 VAC per AC Power Supply 7 A @ 200 VAC per AC Power Supply 5.8 A @ 240 VAC per AC Power Supply
Maximum System Power Input	3000W
3 AC Power Supply Operation	1000W @ 100V
3 AC Power Supply Operation	950W @ 200V

## E300 DC PEM Power Requirements

<b>Parameter</b>	<b>Specifications</b>
Maximum System Power Dissipation	2400W
Maximum DC PEM Input Current	60A
Maximum System Power Input	3000W
3 AC Power Supply Operation	1000W @ 100V
3 AC Power Supply Operation	950W @ 200V

## E300 Module Power Requirements

<b>Module</b>	<b>Power Requirement in Watts (in BTU/hour)</b>
SFM	55W (188 BTU/hour)
E300 RPM	115W (BTU/hour)
E300 fan tray	85 W

## E600i Specifications

### E600i TeraScale Chassis Physical Design

<b>Parameter</b>	<b>Specifications</b>
Height	28 inches (71.1 cm)

Parameter	Specifications
Width	17.4 inches (44.2 cm)
Depth (without cable management system)	21.5 inches (54.6 cm)
Chassis weight with factory-installed components (backplane and air filter)	81 pounds (36.7 kg)
Weight fully loaded (backplane, air filter, fan tray, SFMs, RPMs, and 7 line cards)	242 pounds (109.8 kg)

### Maximum Thermal Output



**NOTE:** Thermal output is directly proportional to system configuration and number of line cards.

Maximum for fully loaded chassis	120 VAC powered: 4705W (16,065 BTU/hour)
	200/240 VAC powered: 4250W (14,500 BTU/hour)
	DC powered: 2800W (9600 BTU/hour)

## E600i TeraScale Environmental Parameters

Parameter	Specifications
<b>Operating</b>	
Temperature	32° to 104°F (0° to 40°C)
Maximum altitude	No performance degradation to 10,000 feet (3,048 meters)
Relative humidity	5 to 85 percent, non-condensing
<b>Non-operating</b>	
Temperature	-40° to 158°F (-40° to 70°C)
Maximum Altitude	15,000 feet (4,572 meters)
Relative Humidity	5 to 95 percent, non-condensing

## E600i TeraScale AC Power Supply Unit Requirements

Parameter	Specifications
Nominal input voltage	120 - 240 VAC 50/60 Hz



<b>Parameter</b>	<b>Specifications</b>
Maximum AC Power Supply Input	16 A @ 100 VAC per module 12 A @ 200 VAC per module
Maximum Thermal Output (3,172 W)	10,822 BTU/hour at 100/120 VAC
Maximum Thermal Output (2,906 W)	9,914 BTU/hour at 200/240 VAC
Maximum AC Supply Input Current	11.6 A @ 100 VAC
(based on 2500 W output for 100/120V and 200/240V lines.)	9.7 A @ 120 VAC 8.0 A @ 200 VAC 6.7 A @ 240 VAC
Maximum System Power Input	3.5 KVA @ 100/120 VAC 3.2 KVA @ 220/240 VAC
Maximum Power Consumption	3,422 W at 100/120 VAC 3,156 W at 200/240 VAC

## E600i ExaScale Chassis Physical Design

<b>Parameter</b>	<b>Specifications</b>
Height	28 inches (71.1 cm)
Width	17.4 inches (44.2 cm)
Depth (without cable management system)	21.5 inches (54.6 cm)
Chassis weight with factory-installed components (backplane and air filter)	81 pounds (36.7 kg)
Weight fully loaded (backplane, air filter, fan tray, SFMs, RPMs, and 7 line cards)	242 pounds (109.8 kg)

### Maximum Thermal Output



**NOTE:** Thermal output is directly proportional to system configuration and number of line cards.

<b>Parameter</b>	<b>Specifications</b>
Maximum for fully loaded chassis	120 VAC powered: 4705W (16,065 BTU/hour) 200/240 VAC powered: 4250W (14,500 BTU/hour) DC powered: 2800W (9600 BTU/hour)

## E600i ExaScale Environmental Parameters

<b>Parameter</b>	<b>Specifications</b>
<b>Operating</b>	
Temperature	32° to 104°F (0° to 40°C)
Maximum altitude	No performance degradation to 10,000 feet (3,048 meters)
Relative humidity	5 to 85 percent, non-condensing
<b>Non-operating</b>	
Temperature	-40° to 158°F (-40° to 70°C)
Maximum Altitude	15,000 feet (4,572 meters)
Relative Humidity	5 to 95 percent, non-condensing

## E600i ExaScale AC Power Supply Unit Requirements

<b>Parameter</b>	<b>Specifications</b>
Nominal input voltage	120 - 240 VAC 50/60 Hz
Maximum AC Power Supply Input	16 A @ 100 VAC per module 12 A @ 200 VAC per module
Maximum Thermal Output (3,172 W)	10,822 BTU/hour at 100/120 VAC
Maximum Thermal Output (2,906 W)	9,914 BTU/hour at 200/240 VAC
Maximum AC Supply Input Current (based on 2500 W output for 100/120V and 200/240V lines.)	11.6 A @ 100 VAC 9.7 A @ 120 VAC 8.0 A @ 200 VAC 6.7 A @ 240 VAC
Maximum System Power Input	3.5 KVA @ 100/120 VAC 3.2 KVA @ 220/240 VAC

Parameter	Specifications
Maximum Power Consumption	3,422 W at 100/120 VAC 3,156 W at 200/240 VAC

## E1200i Specifications

### E1200i TeraScale Chassis Physical Design

Parameter	E1200i AC Specifications	E1200i DC Specifications
Height	42 inches (106.68 cm)	36.75 inches (93.35 cm)
Width	17.40 inches (44.20 cm)	17.40 inches (44.20 cm)
Depth (without cable management system)	22.25 inches (56.51 cm)	21.25 inches (53.98 cm)
Chassis weight with factory-installed components (backplane and air filter)	139 pounds (approx.) (63.05kg)	97 pounds (approx.) (44.00 kg)
Weight fully loaded (backplane, air filter, 2 fan trays, 10 SFMs, RPMs, and 14 line cards)	394 pounds (approx.) (178.7 kg)	319 pounds (approx.) (144.70 kg)
<b>Thermal Output</b>		
Maximum for fully loaded chassis	7,784W (26,578BTU/HR)	6850W (23,389 BTU/HR)
Minimum for chassis with one 48-port 1GE line card	1,450W (4,951 BTU/HR)	1,450W (4,951 BTU/HR)

### E1200i TeraScale Environmental Parameters

Parameter	Specifications
<b>Operating</b>	
Temperature	32° to 104°F (0° to 40°C)
Maximum altitude	No performance degradation to 10,000 feet (3,048 meters)
Relative humidity	5 to 85 percent, non-condensing
Shock	Designed to meet Telcordia GR-63 CORE

<b>Parameter</b>	<b>Specifications</b>
Vibration	Designed to meet Telcordia GR-63 CORE
<b>Non-operating</b>	
Temperature	-40° to 158°F (-40° to 70°C)
Maximum Altitude	15,000 feet (4,572 meters)
Relative Humidity	5 to 95 percent, non-condensing
Vibration	Bellcore GR-63

### E1200i TeraScale Power Requirements

<b>Parameter</b>	<b>E1200i AC Specifications</b>	<b>E1200i DC Specifications</b>
Nominal input voltage	200-240 VAC 50/60 Hz	-44 to 60 VDC
Maximum Power Consumption	5,734 @ 200/240 VAC	5,210 W
Maximum Thermal Output	18,710 BTU/hour (5,484 W)	16,924 BTU/hour (4,910 W)
Maximum Input Current	(per power supply) 15.0 A @ 200 VAC 12.5 A @ 240 VAC	(per DC PEM) 150 A
Maximum System Power Input	5.8 KVA @ 200/240 VAC	

### E1200i ExaScale Chassis Physical Design

<b>Parameter</b>	<b>E1200i AC Specifications</b>	<b>E1200i DC Specifications</b>
Height	42 inches (106.68 cm)	36.75 inches (93.35 cm)
Width	17.40 inches (44.20 cm)	17.40 inches (44.20 cm)
Depth (without cable management system)	22.25 inches (56.51 cm)	21.25 inches (53.98 cm)
Chassis weight with factory-installed components (backplane and air filter)	139 pounds (approx.) (63.05kg)	97 pounds (approx.) (44.00 kg)

<b>Parameter</b>	<b>E1200i AC Specifications</b>	<b>E1200i DC Specifications</b>
Weight fully loaded (backplane, air filter, 2 fan trays, 10 SFM3s, RPMs, and 14 line cards)	422 pounds (approx.) (191.2 kg)	319 pounds (approx.) (144.70 kg)
<b>Thermal Output</b>		
Maximum (fully-loaded chassis with 10-port 10GE line cards)	18,368 BTU/hr	16,446 BTU/hr
Minimum (chassis with one 10-port 10GE line card)	2,313 BTU/hr	1,997 BTU/hr

## E1200i ExaScale Environmental Parameters

<b>Parameter</b>	<b>Specifications</b>
<b>Operating</b>	
Temperature	32° to 104°F (0° to 40°C)
Maximum altitude	No performance degradation to 10,000 feet (3,048 meters)
Relative humidity	5 to 85 percent, non-condensing
Shock	Designed to meet Telcordia GR-63 CORE
Vibration	Designed to meet Telcordia GR-63 CORE
<b>Non-operating</b>	
Temperature	-40° to 158°F (-40° to 70°C)
Maximum Altitude	15,000 feet (4,572 meters)
Relative Humidity	5 to 95 percent, non-condensing
Vibration	Bellcore GR-63

## E1200i ExaScale Power Requirements

<b>Parameter</b>	<b>E1200i AC Specifications</b>	<b>E1200i DC Specifications</b>
Nominal input voltage	200-240 VAC 50/60 Hz	-44 to 60 VDC
Maximum Power Consumption	6,634 W	5,400 W

<b>Parameter</b>	<b>E1200i AC Specifications</b>	<b>E1200i DC Specifications</b>
Maximum Thermal Output	19,449 BTU/hour (5,700 W)	17,402 BTU/hour (5,100 W)
Maximum Input Current	(per power supply) 15.0 A @ 200 VAC 12.5 A @ 240 VAC	(per DC PEM) 150 A
Maximum System Power Input	6.0 KVA @ 200/240 VAC	

# Installing the Software

## Navigating CLI Modes

The FTOS prompt changes to indicate the CLI mode. You must move linearly through the command modes, with the exception of the **end** command which takes you directly to EXEC Privilege mode; the **exit** command moves you up one command mode level.

## Console Access

### RPM Ports and Cables

There are three ports on the RPM: the Console port, the Auxiliary port, and the 10/100 Ethernet port. This chapter includes information to connect to the system using the console port. For information about connecting with the other ports, refer to your system's Installation Guide.

### Connecting the Console



**NOTE:** Before starting this procedure, be sure you have a terminal emulation program already installed on your PC.

Step	Task
1	Install an RJ-45 copper cable into the console port. Use a rollover cable to connect the S4810 console port to a terminal server.
2	Connect the other end of the cable to the DTE terminal server.

Step	Task
3	<p>Default terminal settings on the console are set as follows:</p> <ul style="list-style-type: none"> <li>• 9600 baud rate (to avoid autobaud input, the default is set to a 9600 bps baud rate)</li> <li>• No parity</li> <li>• 8 data bits</li> <li>• 1 stop bit</li> <li>• Window Terminal Emulator option set to NO</li> <li>• 24 lines X 80 characters</li> <li>• No flow control (console port only)</li> <li>• Hardware flow control (RTS/CTS) (for auxiliary port only)</li> </ul>

### Accessing the Console with a DB-9 Adapter

You can connect to the console using a RJ-45 to RJ-45 rollover cable and a RJ-45 to DB-9 female DTE adapter (labeled “TERMINAL”) to a terminal server (for example, PC).

### Pin Assignments Between the E-Series Console and a DTE Terminal Server

Console Port	RJ-45 to RJ-45 Rollover Cable		RJ-45 to DB-9 Adapter	Terminal Server Device
Signal	RJ-45 Pinout	RJ-45 Pinout	DB-9 Pin	Signal
RTS	1	8	8	CTS
DTR	2	7	6	DSR
TxD	3	6	2	RxD
GND	4	5	5	GND
GND	5	4	5	GND
RxD	6	3	3	TxD
DSR	7	2	4	DTR
CTS	8	1	7	RTS



## Accessing the Console with a DB-25 Adapter

You can connect to the console using an RJ-45 to RJ-45 rollover cable and RJ-45 to DB-25 female DTE adapter.

### Pin Assignments Between the E-Series Console and a DB-25 Adapter

Console Port	RJ-45 to RJ-45 Rollover Cable		RJ-45 to DB-25 Modem Adapter	Terminal Server Device
Signal	RJ-45 Pinout	RJ-45 Pinout	DB-25 Pinout	Signal
RTS	1	8	5	CTS
DTR	2	7	6	DSR
TxD	3	6	3	RxD
GND	4	5	7	GND
GND	5	4	7	GND
RxD	6	3	2	TxD
DSR	7	2	20	DTR
CTS	8	1		RTS

## E1200i ExaScale Universal Serial Bus Ports

There are 2 USB ports, labeled A and B. The A port is a host port and allows a user to install a flash memory stick for use as external flash. The B port is a device port and allows a user to hook up an external PC for console access. Refer to the *E1200i ExaScale Installation Guide* for complete information regarding these ports.

## Default Configuration

A version of FTOS is pre-loaded onto the chassis, however the system is not configured when you power up for the first time (except for the default host name, which is `Force10`). You must configure the system using the CLI.

# Configure Layer 2 (Data Link) Mode

Use the **switchport** command in INTERFACE mode to enable Layer 2 data transmissions through an individual interface. The user cannot configure switching or Layer 2 protocols such as the spanning tree protocol on an interface unless the interface has been set to Layer 2 mode.

Step	Task	Command Syntax	Command Mode
1	Enable the interface.	<b>no shutdown</b>	INTERFACE
2	Place the interface in Layer 2 (switching) mode.	<b>switchport</b>	INTERFACE

To view the interfaces in Layer 2 mode, use the **show interfaces switchport** command in the EXEC mode.

# Configure a Host Name

The host name appears in the prompt. The default host name is `Force10`.

- Host names must start with a letter and end with a letter or digit.
- Characters within the string can be letters, digits, and hyphens.

Task	Command Syntax	Command Mode
Create a new host name.	<b>hostname</b> <i>name</i>	CONFIGURATION

# Access the System Remotely

You can configure the system to be accessed remotely by Telnet.

The E-Series systems have a dedicated management port and a management routing table that is separate from the IP routing table.

Configuring the system for Telnet is a three-step process:

- Configure an IP address for the management port.
- Configure a management route with a default gateway.
- Configure a username and password.

## Configure the Management Port IP Address

Assign IP addresses to the management ports in order to access the system remotely.



**NOTE:** Assign different IP addresses to each RPM's management port.

Step	Task	Command Syntax	Command Mode
1	Enter INTERFACE mode for the Management port.	<b>interface</b> <b>ManagementEthernet</b> <i>slot/port</i>	CONFIGURATION
2	Assign an IPv4 or IPv6 address to the interface.	<b>ip address</b> { <i>ipv4-address</i>   <i>ipv6-address</i> }/ <i>mask</i>	INTERFACE
3	Enable the interface.	<b>no shutdown</b>	INTERFACE

## Configure a Management Route

Define a path from the system to the network from which you are accessing the system remotely. Management routes are separate from IP routes and are only used to manage the system through the management port.

Task	Command Syntax	Command Mode
Configure an IPv4 or IPv6 management route to the network from which you are accessing the system.	<b>management route</b> { <i>ipv4-address</i>   <i>ipv6-address</i> }/ <i>mask gateway</i>	CONFIGURATION

## Configure a Username and Password

Configure a system username and password to access the system remotely.

Task	Command Syntax	Command Mode
Configure a username and password to access the system remotely.	<b>username</b> <i>username</i> <b>password</b> <i>[encryption-type] password</i>	CONFIGURATION

## Configure the Enable Password

The EXEC Privilege mode is accessed by the **enable** command. Configure a password as a basic security measure. When using a console connection, EXEC Privilege mode is unrestricted by default; it cannot be reached by a VTY connection if no password is configured. There are two types of enable passwords:

- enable password stores the password in the running/startup configuration using a DES encryption method.
- enable secret is stored in the running/startup configuration in using a stronger, MD5 encryption method.

Dell Force10 recommends using the enable secret password.

Task	Command Syntax	Command Mode
Create a password to access EXEC Privilege mode.	<b>enable</b> [ <b>password</b>   <b>secret</b> ] [ <b>level</b> <i>level</i> ] <i>[encryption-type] password</i>	CONFIGURATION

## Create a VLAN

The Default VLAN is part of the system startup configuration, and is by default, VLAN 1. You may make another VLAN the Default VLAN. The Default VLAN cannot be deleted, disabled, or configured (you cannot assign it an IP address), and only untagged interfaces can belong to it.

When an interface is configured, a switchport automatically places it in the Default VLAN as an untagged interface. All switchports must belong to at least one VLAN, so to remove a switchport from the Default VLAN, you must place it as tagged or untagged in some other VLAN, or remove the switchport configuration.

Task	Command Syntax	Command Mode
Create a VLAN	<b>interface vlan</b> <i>vlan-id</i>	CONFIGURATION
Display all VLANs.	<b>show vlan</b> <i>vlan-id</i>	EXEC Privilege

## Assign Interfaces to a VLAN

A port may either be an untagged member of a single VLAN, or a tagged member of perhaps multiple VLANs.

- **Untagged Ports** — ports that do not append an 802.1Q VLAN tag to frames on egress, and do not accept tagged frames on ingress (tagged frames are dropped). Untagged ports must be connected to VLAN-unaware devices.
- **Tagged Ports** — ports that append an 802.1Q tag to frames on egress, and accept only tagged frames on ingress (untagged frames are dropped). Tagged ports must be connected to VLAN-aware devices.

When you configure an enabled port as a switchport, the port is placed in the default VLAN. To remove a switchport from the default VLAN, remove the switchport configuration. To move the port to another VLAN, add it to the desired VLAN as either a tagged or untagged member.

To view just the interfaces that are in Layer 2 mode, enter the **show interfaces switchport** command in the EXEC mode.

Step	Task	Command Syntax	Command Mode
1	Assign a switchport to a VLAN.	<b>[tagged   untagged]</b> <i>interface</i>	INTERFACE VLAN
2	Display all switchports and the VLANs of which they are members.	<b>show vlan</b>	EXEC Privilege

## Assign an IP Address to a VLAN



**NOTE:** An IP address cannot be assigned to the Default VLAN, which, by default, is VLAN 1. To assign another VLAN ID to the Default VLAN, use the default **vlan-id** *vlan-id* command.

Task	Command Syntax	Command Mode
Configure an IP address and mask on the interface.	<b>ip address</b> <i>ip-address</i> <i>mask [secondary]</i>	INTERFACE

## Connecting the Chassis to the Network

Once you have completed the hardware installation and software configuration, you can connect to your company network by following your company's cabling requirements.











Printed in the U.S.A.

[www.dell.com](http://www.dell.com) | [support.dell.com](http://support.dell.com)



08VJV0A00